

Data Sheet

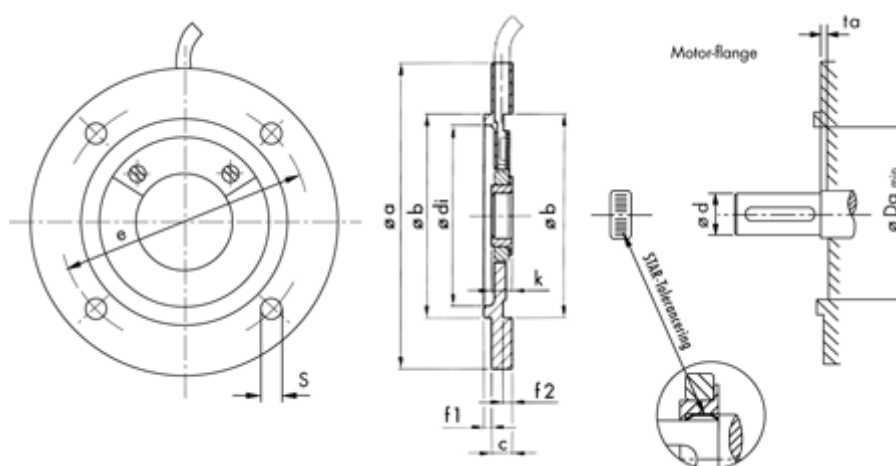

Article number: 7806142403680050
Description: BEGE flangeencoder for 90B14
MN140-24-368-5 (5m) 5-24V

Measures



$a = 140$	$f_2 = 4.0$
$b = 95$	$k = 9$
$c = 9$	$s = 9$
$d = 24$	$ta = 3$
$Da = 60$	
$di = 85$	
$e = 115$	
$f_1 = 3.5$	